

Bảng thông số sản phẩm

Thông số kỹ thuật



miniature, Harmony Electromechanical Relays, 5A, 2CO, with LED, 230V AC

RXM2LB2P7

Main

| | |
|--|----------------------------------|
| Range of product | Harmony Electromechanical Relays |
| Coil interference suppression | Without |
| Series name | Miniature |
| product or component type | Plug-in relay |
| Device short name | RXM |
| Contacts type and composition | 2 C/O |
| [Ithe] conventional enclosed thermal current | 5 A at -40...55 °C |

Complementary

| | |
|--|--|
| Contact operation | Standard |
| [Uc] control circuit voltage | 230 V AC 50/60 Hz |
| Status LED | With |
| Control type | Without push-button |
| [Uimp] rated impulse withstand voltage | 4 kV during 1.2/50 μ s conforming to IEC 61810-7 |
| [Ie] rated operational current | 5 A (AC-1/DC-1) NO conforming to IEC 2.5 A (AC-1/DC-1) NC conforming to IEC 1 A at 28 V (DC-13) NO |
| Minimum switching capacity | 25 mW subject to switching frequency, environment or expected reliability level etc |
| Average coil consumption in VA | 1.2 AC |
| Operating time | 20 ms between coil de-energisation and making of the Off-delay contact 20 ms between coil energisation and making of the On-delay contact |
| CAD overall width | 21 mm |
| CAD overall height | 27 mm |
| CAD overall depth | 46 mm |
| Minimum switching current | 5 mA subject to switching frequency, environment or expected reliability level etc |
| Minimum switching voltage | 5 V subject to switching frequency, environment or expected reliability level etc |
| Rated operational voltage limits | 184...253 V AC |
| [Ui] rated insulation voltage | 250 V conforming to IEC |
| Maximum switching voltage | 250 V AC 28 V DC |
| Drop-out voltage threshold | $\geq 0.15 U_c$ AC |
| Load current | 5 A at 250 V AC 5 A at 28 V DC |

| | |
|--------------------------------------|--|
| Maximum switching capacity | 1250 VA AC 140 W DC |
| Average resistance | 16500 Ohm at 23 °C +/- 15 % |
| Mechanical durability | 10000000 cycles |
| Electrical durability | 100000 cycles for resistive load 50000 cycles, 1 A at 28 V, DC-13 NO |
| Safety reliability data | B10d = 100000 |
| Operating rate | <= 1200 cycles/hour under load <= 18000 cycles/hour no-load |
| Utilisation coefficient | 20 % |
| Dielectric strength | 2000 V AC between coil and contact with basic insulation 2000 V AC between poles with basic insulation 1000 V AC between contacts with micro disconnection |
| Protection category | RT I |
| Pollution degree | 3 |
| Operating position | Any position |
| Test levels | Level A group mounting |
| Sale per indivisible quantity | 10 |
| Contacts material | Silver alloy (Ag/Ni) |
| net weight | 0.031 kg |

Environment

| | |
|--|--|
| IP degree of protection | IP40 conforming to IEC 60529 |
| Standards | CE IEC 61810-1 (iss. 2) |
| Ambient air temperature for storage | -40...85 °C |
| Vibration resistance | 3 gn, amplitude = +/- 1 mm (f = 10...50 Hz)operating conforming to IEC 60068-2-6 6 gn, amplitude = +/- 1 mm (f = 10...50 Hz)not operating conforming to IEC 60068-2-6 |
| Shock resistance | 30 gn for not operating conforming to IEC 60068-2-27 10 gn for in operation conforming to IEC 60068-2-27 |

Packing Units

| | |
|-------------------------------------|-----------|
| Unit Type of Package 1 | PCE |
| Number of Units in Package 1 | 1 |
| Package 1 Height | 2.000 cm |
| Package 1 Width | 3.000 cm |
| Package 1 Length | 4.500 cm |
| Package 1 Weight | 32.000 g |
| Unit Type of Package 2 | BB1 |
| Number of Units in Package 2 | 10 |
| Package 2 Height | 3.000 cm |
| Package 2 Width | 10.500 cm |
| Package 2 Length | 12.000 cm |
| Package 2 Weight | 348.000 g |

| | |
|-------------------------------------|-----------|
| Unit Type of Package 3 | S02 |
| Number of Units in Package 3 | 240 |
| Package 3 Height | 15.000 cm |
| Package 3 Width | 30.000 cm |
| Package 3 Length | 40.000 cm |
| Package 3 Weight | 8.612 kg |

Contractual warranty

| | |
|-----------------|-----------|
| Warranty | 18 months |
|-----------------|-----------|

Bền vững

Nhãn **Green Premium™** là cam kết của Schneider Electric trong việc cung cấp sản phẩm với hiệu suất môi trường tốt nhất. Green Premium cam kết tuân thủ các quy định mới nhất, minh bạch về tác động môi trường, cũng như các sản phẩm tuần hoàn và CO₂ thấp.

Hướng dẫn đánh giá tính bền vững của sản phẩm là tài liệu kỹ thuật phổ thông giúp làm rõ các tiêu chuẩn nhân sinh thái toàn cầu và cách diễn giải việc khai báo môi trường.

[Tìm hiểu thêm về Green Premium >](#)

[Hướng dẫn đánh giá về sự bền vững của sản phẩm >](#)



Minh bạch **RoHS/REACH**

Hiệu suất sức khỏe

Reach Free Of Svhc

Toxic Heavy Metal Free

Mercury Free

Rohs Exemption Information Yes

Chứng nhận & Tiêu chuẩn

Reach Regulation

[REACH Declaration](#)

Eu Rohs Directive

Pro-active compliance (Product out of EU RoHS legal scope)

[EU RoHS Declaration](#)

China Rohs Regulation

[China RoHS declaration](#)

Environmental Disclosure

[Product Environmental Profile](#)

Weee

The product must be disposed on European Union markets following specific waste collection and never end up in rubbish bins

Circularity Profile

[End of Life Information](#)

Bảng thông số sản phẩm

RXM2LB2P7

Dimensions Drawings

Dimensions

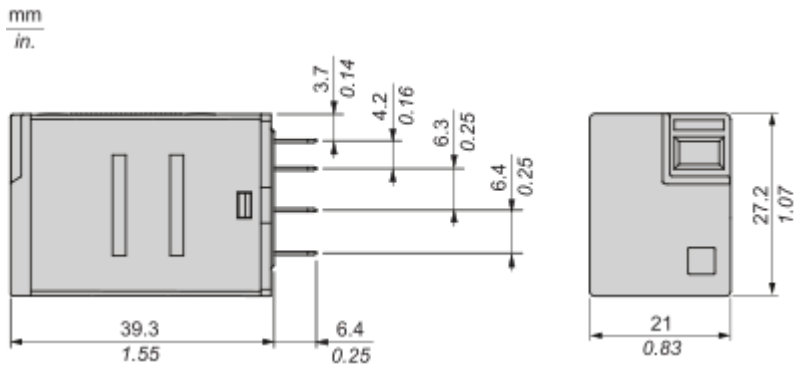

Pin Side View

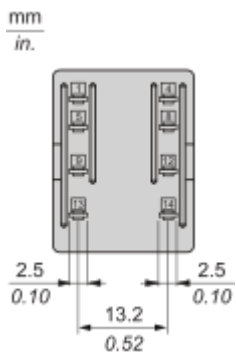

Connections and Schema

Wiring Diagram

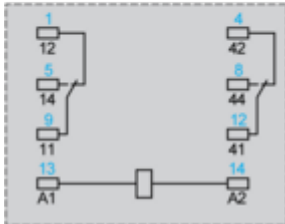
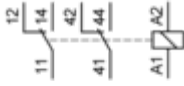

Symbols shown in blue correspond to Nema marking.

Performance Curves

Electrical Durability of Contacts

Durability (inductive load) = durability (resistive load) x reduction coefficient.

For 2 Poles Relay

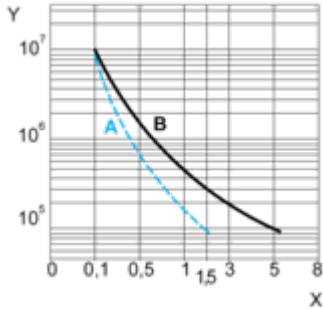

X : Contact current (A)

Y : Durability (Number of operating cycles)

A : Inductive load

B : Resistive load

Note : These are typical curves, actual durability depends on load, environment, duty cycle, etc.

For inductive load, to increase relay life cycles, please add a proper load protection circuit (eg: RC protection/Varistor/free Wheeling diode -DC load only-)

Maximum Switching Capacity

For 2 Poles Relay

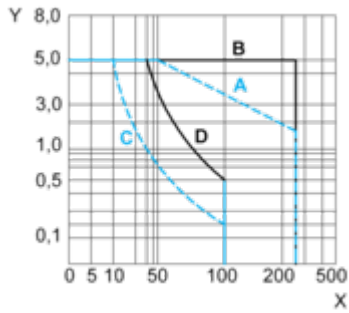

X : Contact voltage (v)

Y : Contact current (A)

A : Inductive AC load

B : Resistive AC load

C : Inductive DC load

D : Resistive DC load

Note : These are typical curves, actual durability depends on load, environment, duty cycle, etc.

For inductive load, to increase relay life cycles, please add a proper load protection circuit (eg: RC protection/Varistor/free Wheeling diode -DC load only-)

For low level loads (below 10mA), we recommend to use RXM*GB series with bifurcated contacts relays instead.

AC Coil Voltage and Operating Temperature under continuous duty

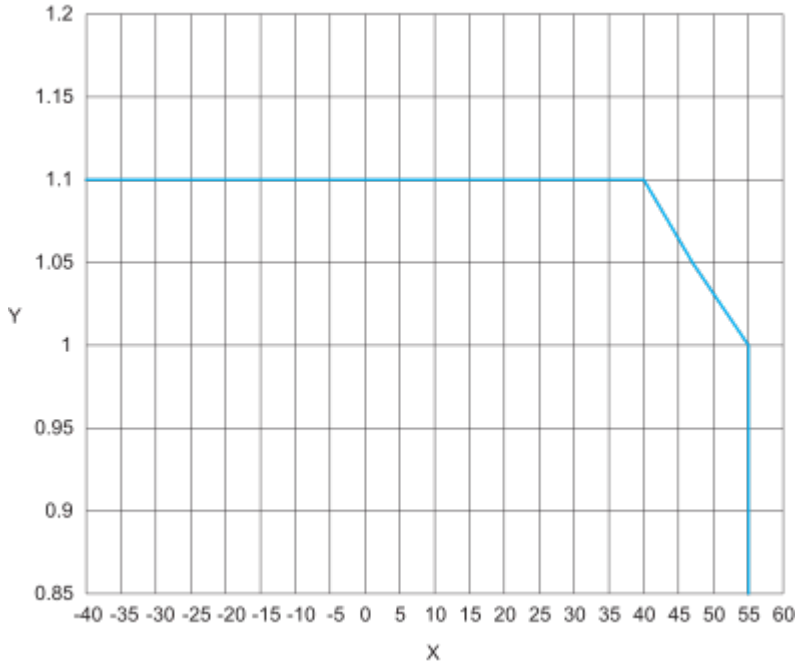

X : Operating temperature (°C)

Y : AC coil voltage (UC)